

Article number: 03504100

Description: Fluro Rod end GE 100LO

Measures

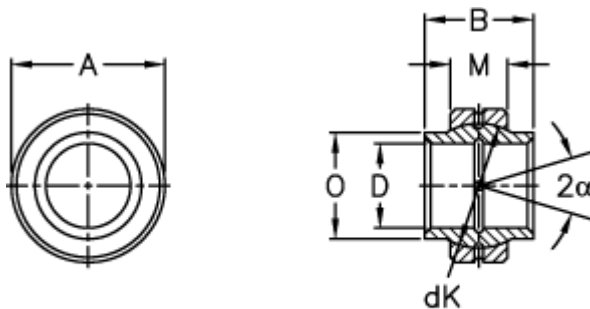

Str. 12 den smørerille

A	= 150 0 -0,018	Tilt angle = 4
B	= 100	Weight = 4700
D	= 100 0 +0,035	
dK	= 130	
Dynamic load C (kN)	= 610	
M	= 55	
O	= 113	
Static load C0 (kN)	= 3050	